

Installation Instructions

For model series:

PVWC600

PVWN600

PVWM600

PVWS600

PVBN600

PVBC600

PVBM600

PVBS600

PVFE600

Model shown:
PVWN600

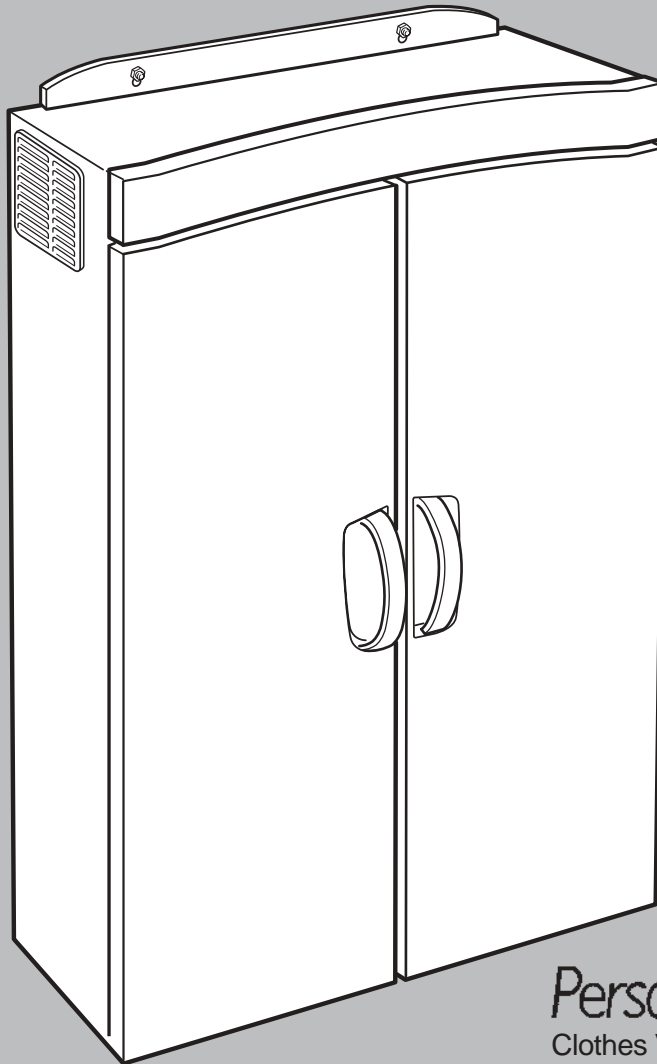

Personal Valet™
Clothes Vitalizing System

Part No. 8527389

⚠ WARNING



Tip Over Hazard

Do not use clothes vitalizer until completely installed.

Install lag bolts securely into wall studs.

Use two or more people to move and install clothes vitalizer.

Reapply tape or strap to secure doors before moving clothes vitalizer.

Failure to follow these instructions can result in death or serious injury.

IMPORTANT: Read and save these instructions.

IMPORTANT:

Installer: Leave Installation Instructions with the owner.

Owner: Keep Installation Instructions for future reference.

Save: Installation Instructions for local electrical inspector's use.

Before you start...

Your safety and the safety of others are very important.

We have provided many important safety messages in this manual and on your appliance. Always read and obey all safety messages.



This is the safety alert symbol.

This symbol alerts you to potential hazards that can kill or hurt you and others.

All safety messages will follow the safety alert symbol and either the word "DANGER" or "WARNING". These words mean:

⚠ DANGER

You can be killed or seriously injured if you don't immediately follow instructions.

⚠ WARNING

You can be killed or seriously injured if you don't follow instructions.

All safety messages will tell you what the potential hazard is, tell you how to reduce the chance of injury, and tell you what can happen if the instructions are not followed.

It is your responsibility to:

Observe all governing codes and ordinances.

Check code requirements: Some codes limit or do not permit installation of this product in garages, closets, mobile homes or sleeping quarters. Contact your local building inspector.

Comply with the installation specifications and dimensions.

Consider spacing requirements for companion appliances.

Make sure you have everything necessary for proper installation.

Properly install appliance.

Contact a qualified installer to insure that the electrical installation meets all national and local codes and ordinances.

Electrical requirements

⚠ WARNING



Electrical Shock Hazard
Plug into a grounded 3-prong outlet.

Do not remove ground prong.

Do not use an adapter.

Do not use an extension cord.

Failure to follow these instructions can result in death, fire, or electrical shock.

Important: Observe all governing codes and ordinances.

A 120-volt, 60-Hz, AC-only, 15- or 20-ampere fused electrical supply is required. A Time-delay fuse or circuit breaker is recommended.

It is recommended that a separate circuit serving only this appliance be provided.

If codes permit and a separate ground wire is used, it is recommended that a qualified electrician determine that the ground path is adequate.

3-prong ground-type outlet must be located within 5 feet of lower right corner of appliance.

Recommended ground method

The clothes vitalizer, when installed, must be electrically grounded in accordance with local codes, or in the absence of local codes, with National Electrical Code, ANSI/NFPA 70*.

GROUNDING INSTRUCTIONS: This clothes vitalizer must be grounded. In the event of malfunction or breakdown, grounding will reduce the risk of electric shock by providing a path of least resistance for electric current.

Copies of the standards listed above may be obtained from:

* National Fire Protection Association
One Batterymarch Park
Quincy, Massachusetts 02269

The power supply cord plug must be plugged into an appropriate outlet that is properly installed and grounded in accordance with all local codes and ordinances.

WARNING – Improper connection of the equipment-grounding conductor can result in a risk of electric shock. Check with a qualified electrician or serviceman if you are in doubt as to whether the appliance is properly grounded. Do not modify the plug provided with the appliance – if it will not fit the outlet, have a proper outlet installed by a qualified electrician.

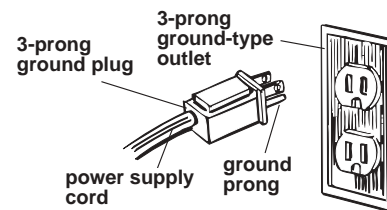

Tools needed for installation:

- stud finder (optional)
- drill (electric recommended)
- 5/32" drill bit (pilot hole for lag bolt)
- tape measure
- pencil
- carpenter's level
- 7/16" wrench (ratchet recommended) for lag bolts

if installing on a concrete or concrete block wall

- concrete drill bit for wall anchors (refer to wall anchor for drill bit size)
- hammer

if installing on a metal studded wall

- 3/4" drill or as large as needed for spring nut clearance
- magnetic stud finder

if changing the door on Decor series only

- 11/32" wrench
- 1/4" nut driver or wrench
- Phillips screwdriver

Parts supplied for installation:

(inside accessory box)

- 2, 1/4" x 2" lag bolts (for wood studs)
- 2, 1/4-20" nuts
- 1 mounting bracket cover (can be painted or covered with wallpaper)
- separate metal mounting bracket assembly
- 6, 1/8" thick adhesive backed cabinet spacers

Parts not supplied for installation:

- 2, 1/4"x1-1/4" lag bolts with wall anchors for concrete or concrete block wall installations. Note: Lag bolt length is based on mounting bracket thickness only. Add thickness of any wall coverings to length of lag bolts/wall anchors used. These can be obtained from local hardware store.
- 2, 1/4-20x3" toggle bolts and spring nuts for metal studded walls. These can be obtained from local hardware store.

Now start...

⚠ WARNING



Tip Over Hazard

Do not use clothes vitalizer until completely installed.

Install lag bolts securely into wall studs.

Use two or more people to move and install clothes vitalizer.

Reapply tape or strap to secure doors before moving clothes vitalizer.

Failure to follow these instructions can result in death or serious injury.

Product dimensions

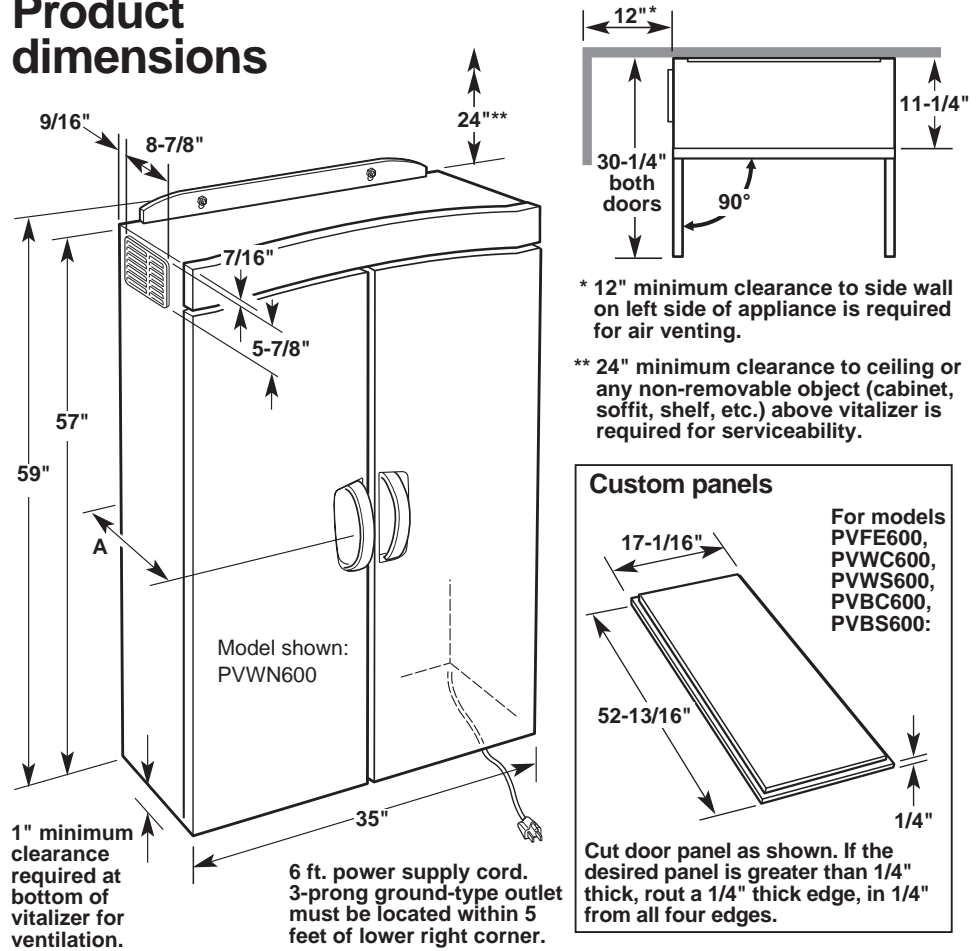

* 12" minimum clearance to side wall on left side of appliance is required for air venting.

** 24" minimum clearance to ceiling or any non-removable object (cabinet, soffit, shelf, etc.) above vitalizer is required for serviceability.

Custom panels

For models PVFE600, PVWC600, PVWS600, PVBC600, PVBS600:

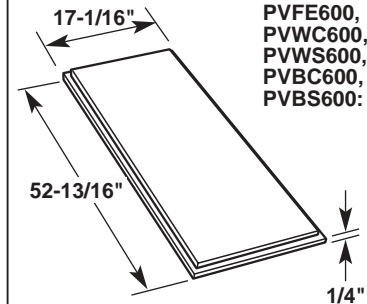

Cut door panel as shown. If the desired panel is greater than 1/4" thick, rout a 1/4" thick edge, in 1/4" from all four edges.

for all models except PVFE600	weight	overall depth (incl. handle) A	panel dimensions
white doors	117 lbs.	15-1/4"	—
biscuit doors	117 lbs.	15-1/4"	—
wood panel doors	137 lbs.	15-1/8"	17-1/16" x 52-13/16" x 1/4" thick
mirrored doors	143 lbs.	15-1/8"	17-1/16" x 52-13/16" x 1/4" thick

Installation steps

1. With clothes vitalizer in carton, lay carton on back. Open doors no more than 90° to avoid damaging door hinges and remove contents. Important: Follow removal instructions printed on front of accessory box.

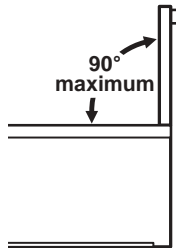

If installing model PVFE600, or if a custom door panel is to be installed on models PVWC600, PVWS600, PVBC600, PVBS600, see "Product dimensions" on this page for custom panel size and then go to "Installing custom door panels" on Page 5.

Note: It is not recommended to customize mirrored models PVWM600 or PVBM600.

2. Shut doors and reapply tape or strap. Leave clothes vitalizer in box.

3. Remove the mounting bracket assembly, nuts and lag bolts (if installing in wall studs) from the accessory box.

With washer sides of nuts facing mounting bracket, start nuts onto the bracket's threaded studs.

4. Mark a horizontal line at least 24 inches long, 70-3/4" minimum from the floor. Important: The line MUST be level.

For wood stud installations, go to Step 5.

For metal studded wall installations, go to Step 6.
For concrete or concrete block installations, go to Step 7.

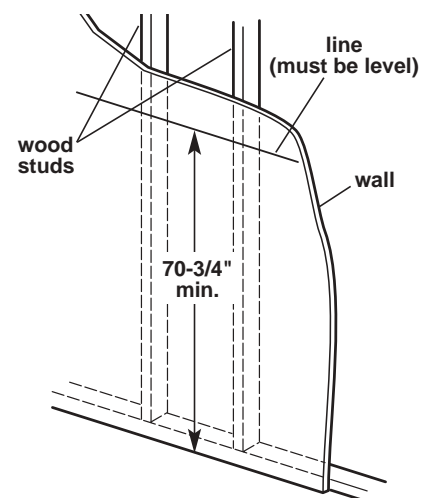

5. Wood stud installations:

Critical step:

For wood stud installations, each lag bolt MUST be installed in a wood stud. If there are not 2 studs in mounting area, DO NOT install vitalizer.

DO NOT use toggle bolts through dry wall to support the clothes vitalizer.

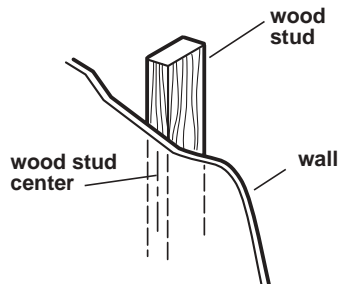

5a. Locate and mark the centers of each wall stud. Make these marks about 72" from the floor.

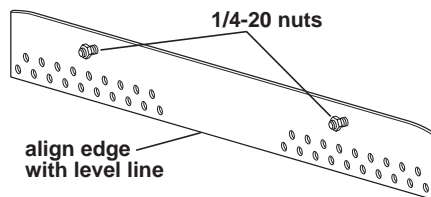

5b. Align the lower edge of the mounting bracket assembly with the level horizontal line. Select and mark a hole location on each side of the bracket that is closest to the center of each stud. Mark the holes to be used on the bracket assembly also.

5c. Set bracket aside and drill 5/32" pilot holes.

5d. Fasten the mounting bracket to wall. Check that the bracket is level then securely tighten the lag bolts.

Go to Step 8.

6. Metal studded wall installations:

Critical step:

For metal studded wall installations, each bolt MUST be installed in a metal stud. If there are not 2 studs in mounting area, DO NOT install vitalizer.

DO NOT use toggle bolts through dry wall to support the clothes vitalizer.

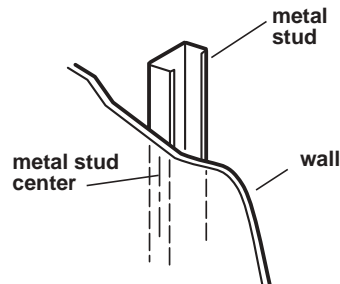

6a. Use a magnetic stud finder to locate and mark the centers of each metal wall stud. Make these marks about 72" from the floor.

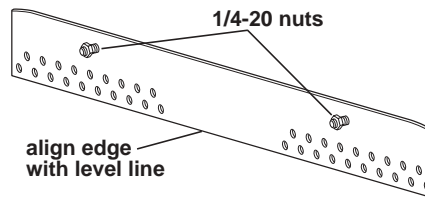

6b. Align the lower edge of the mounting bracket assembly with the level horizontal line. Select and mark a hole location on each side of the bracket that is closest to the center of each stud. Mark the holes to be used on the bracket assembly also.

6c. Set bracket aside and drill 5/32" pilot holes.

6d. Drill 3/4" holes for spring nuts to slide through.

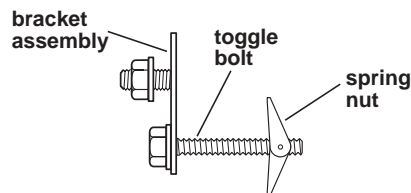

6e. Insert 1/4-20 x 3" toggle bolts through the selected holes in the bracket assembly. Start a spring nut on each toggle bolt. Leave enough space for the spring nut to go through the wall and stud and open up behind the stud.

6f. Position the mounting bracket assembly on the wall and push the toggle bolt and spring nut assemblies through the wall and metal stud. Pull the toggle bolt towards you and finger tighten to insure that spring nuts have opened fully against metal stud.

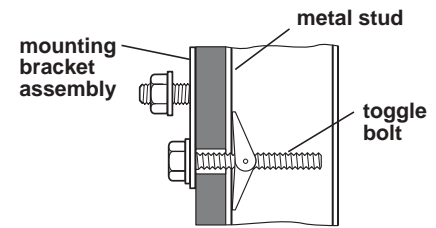

6g. Lightly tighten the toggle bolts. Check that the mounting bracket assembly is level. Securely tighten the toggle bolts.

Go to Step 8.

7. Concrete or concrete block wall installations:

7a. Align the lower edge of the mounting bracket assembly with the level horizontal line. Select and mark a hole location on each side of the bracket.

7b. Set bracket aside and drill holes. Drive the wall anchors into the holes with hammer.

7c. Fasten the mounting bracket to wall. Check that the bracket is level then securely tighten the lag bolts.

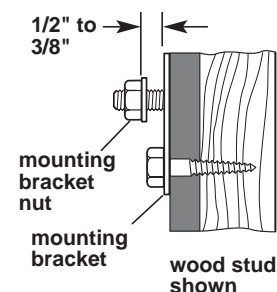

8. Space the mounting bracket nuts 1/2" to 3/8" away from mounting bracket.

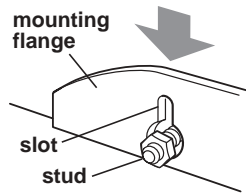

9. Lift clothes vitalizer up and slide keyhole slots over nuts. Lower vitalizer down onto mounting bracket studs and tighten nuts. Remove tape or strap from doors.

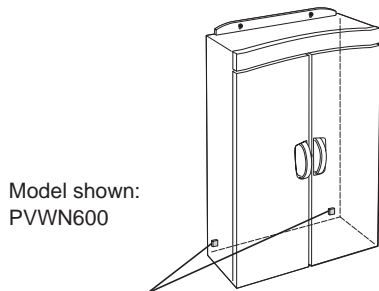

Model shown:
PVWN600

spacers as needed

10. Check tops of doors for uniform vertical alignment. Wall irregularities may require shimming the back bottom corners of the cabinet away from wall to align the door tops.

If door tops are not aligned:

- Carefully pull a bottom cabinet corner away from the wall and observe the alignment shift.
- Separate adhesive backed spacers (in accessory box) but do not remove from the adhesive backing.
- Insert spacers at either or both bottom corners to obtain door alignment. The spacers may be stacked for additional thickness if needed.
- When alignment is obtained, remove the spacers from the adhesive backing and attach to back of cabinet.

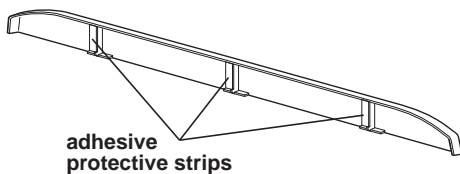

11. Remove mounting bracket cover from accessory box. Peel off adhesive protective strips. Align cover with bracket and press cover against bracket.
Note: Mounting bracket cover can be painted or covered with wallpaper.

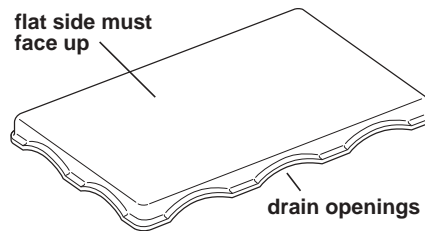

12. Remove collection basin cover from accessory box. With flat side facing up, place into depression in bottom of inner liner.

13. Plug power supply cord into grounded outlet.

14. If your clothes vitalizer came with a storage drawer, follow the instructions packed with the drawer and install it now.

Installing custom door panels

Door removal:

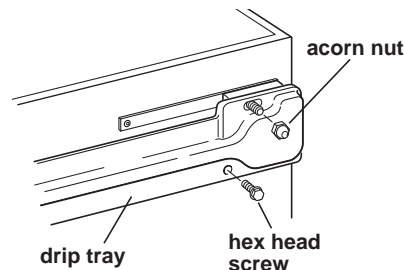

1. Use 11/32" wrench and remove acorn nuts on each end on of drip tray. Use 1/4" nut driver or wrench and remove 4 hex head screws from drip tray. Remove drip tray and set aside along with acorn nuts and screws.

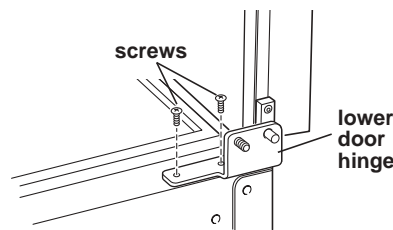

2. Open door 90°. Support door in this position and use Phillips screwdriver to remove both screws from lower door hinge. Set screws and lower hinge aside.

3. Slide door out of upper hinge and set aside. Remove plastic shoulder washer from upper hinge pin and set aside. **Do not lose this washer.**

Remove other door.

Custom panel installation:

1. Lay protective material such as a blanket or cardboard that is slightly larger than the door on floor or any flat support surface.

2. Lay a door on protective surface with door handle facing up.

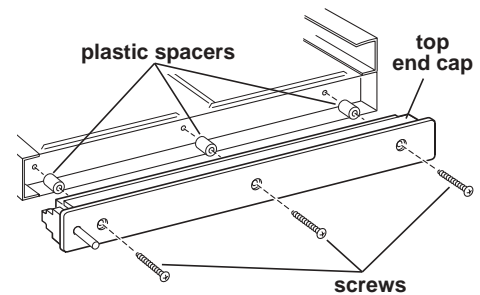

3. Use Phillips screwdriver and remove 3 screws from **top** end cap. (This is same end cap from which shoulder washer was removed.) Remove end cap and set aside. Do not lose the 3 plastic spacers on the screws.

Important: If you are installing models PVWC600, PVWS600, PVBC600, PVBS600, remove and discard the door panel that came with your model. Model PVFE600 does NOT come with panels.

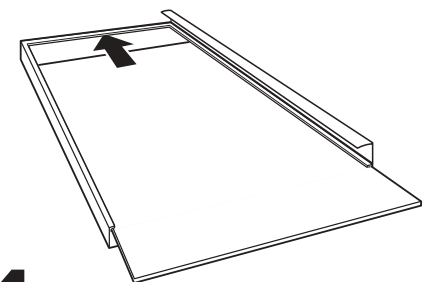

4. Slide custom door panel into door channels until it fits snugly under edge of door's bottom end cap.

5. Reassemble top door end cap. Make sure that the 3 plastic spacers are on screws.

Repeat to install custom panel in other door.

Reassemble doors to clothes vitalizer:

1. Place plastic shoulder washer on upper door hinge pin. Support door in 90° open position and slide door into upper hinge.

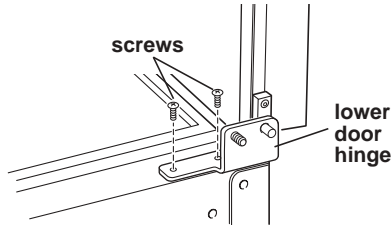

2. With door still in 90° open position, reattach lower door hinge. Use Phillips screwdriver to reinstall both lower door hinge screws. Securely tighten screws.

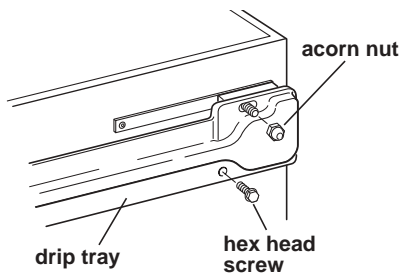

3. Reattach drip tray. Reinstall 4 hex head screws and 2 acorn nuts, one on each end of drip tray. Tighten securely.

Repeat to install other door.

4. Shut doors and reapply tape or strap. Leave clothes vitalizer in carton and go back to Step 2 of "Installation steps" on Page 3 to complete installation.

Important: Before vitalizer is installed, do not open doors more than 90° to avoid damaging door hinges.

If clothes vitalizer does not operate:

- Check that circuit breaker is not tripped or house fuse blown.
- Check that power supply cord is plugged into wall outlet.
- See Owner's Manual for troubleshooting list.

If you need assistance:

- Refer to Owner's Manual.
- Call the Consumer Interaction Center. Check your Owner's Manual for a toll-free number to call or call the dealer from whom you purchased the clothes vitalizer. The dealer is listed in the Yellow Pages of your phone directory under "Appliances – Household – Major — Service and Repair."

If you need service:

Maintain the quality built into your clothes vitalizer by calling an authorized service company.

To obtain the name and number of an authorized service company:

- Contact the dealer from whom you purchased your clothes vitalizer, or
- Look in the Yellow Pages of your phone directory under "Appliances – Household – Major — Service and Repair," or
- Call the Consumer Interaction Center. The toll-free number is listed in your Owner's Manual.

When you call, you will need:

- The clothes vitalizer model number.
- The clothes vitalizer serial number.

Both numbers are listed on the model/serial number plate located on the lower cabinet frame next to the door magnet.

Accessories:

The following storage drawer kits are available from your dealer:

Kit No. 8527309 White

Kit No. 8527310 Biscuit

Kit No. 8527308 Signet Grey